

PUBLIC



Building Design Guide - New Developments

Chief Technology Office - Passive

Document Number: NBN-TE-CTO-284
Document Type: Guide
Status: Final
Issue Date: 21st March 2013
Version Number: 5.0
Classification: PUBLIC

PUBLIC

Disclaimer

This document is provided for information purposes only.

The recipient must not use this document other than with the consent of NBN Co and must make their own inquiries as to the currency, accuracy and completeness of this document and the information contained in it. The contents of this document should not be relied upon as representing NBN Co's final position on the subject matter of this document, except where stated otherwise. Any views expressed by NBN Co in this document may change as a consequence of NBN Co finalising formal technical specifications, or legislative and regulatory developments.

NBN Co does not warrant that the processes and information outlined in this document comply with all (or any) applicable laws. The recipient must exercise its own judgment as to how best to perform the activities described in this document in a safe way, and so as to meet the requirements of all applicable laws.

This document was last updated as at 23rd April, 2013

Contents

About this document	5
1.1 Related Documents	5
1.2 About This Version.....	6
2 Introduction	7
2.1 Scope	7
2.2 General Requirements.....	8
2.2.1 New Development MPS / MDU	8
2.3 ACMA Wiring Rules	8
2.4 Network Boundary Point	8
2.5 Essential Services.....	8
2.5.1 Mounting Template	10
2.6 NBN Co's MPS Categories	12
2.7 General Requirements.....	12
2.7.1 Basic Principles.....	12
2.7.2 Lead-in to the Building Entry.....	12
2.8 Space Requirements for MDU/MPS Products.....	12
2.8.1 Basement or Telecommunications Room.....	12
2.8.2 Cable Transition Location (CTL) Enclosure.....	13
2.8.3 Telecommunications Riser/Closet	14
2.8.4 Working Height and Space	14
2.9 Pathways	16
2.9.1 Property boundary to Telecommunications room:.....	16
2.9.2 Telecommunications Riser/Closet to Living Unit	16
2.9.3 Living Unit	18
2.9.4 Installation Specifications and Rules for NTDs and BBPSUs	22
2.9.5 Ventilation requirements	25
Appendix A – Key Terms	29
Appendix B – MPS/MDU Pathway Design Checklist.....	31

Figures

Figure 1: Basic network elements in relation to a typical MPS	7
Figure 2 - Earthing Requirements	9
Figure 3 – Outdoor NTD Composite Layout (Landscape)	10
Figure 4 – Outdoor NTD Composite Layout (Portrait)	11
Figure 5: Example Fibre / Premises Distribution Hub/Internal Locations Clearance Requirements	13
Figure 6 - Example CTL Clearance Requirements	14
Figure 7 - Example of access clearances for a single FDT or FCD (all dimensions in mm)	14
Figure 8 - Slot Example Telecommunications Riser/Closet Floor or Ceiling Entry.....	15
Figure 9 - Sleeve Example Telecommunications Riser/Closet Floor or Ceiling Entry.....	15
Figure 10 - NBN Co Concept Pathway from Property Boundary to Communications Room	16
Figure 11 - NBN Co Pathway using all P23 ID conduit to feed typical Apartment floor Example layout 1	17
Figure 12 - NBN Co Pathway using combination Cable Tray and P23 ID conduit to feed typical Apartment floor Example layout 2.....	17
Figure 13 – Indoor NTD Landscape Orientation	18
Figure 14 - Mounting Template Indoor NTD Portrait	19
Figure 15 - NBN Co NTD and PSU Dimensions and Clearance Requirements.....	20
Figure 16 – NTD Enclosure Landscape Orientation	21
Figure 17 – NTD Enclosure Portrait Orientation	22
Figure 18 – Ventilation Upper/Lower	26
Figure 19 – Ventilation Openings.....	27

Tables

Table 1 - Outdoor NTD Mounting Template.....	11
Table 2 – MPS Categories	12
Table 3 - Indoor NTD Mounting Template	19
Table 4 - Home Distributor Dimensions	20
Table 5 - NTD Enclosure Mounting Template.....	22
Table 6 – Ventilation Requirements.....	28
Table 7 - Acronym Definitions	30

About this document

Audience	<ul style="list-style-type: none"> • New Development site developers • New Development site designers • Building Contractors <p>This document, in conjunction with documents listed in Appendix B – Key Documents, provides guidelines for developers building Multi Premises Sites (MPS).</p>
Purpose	This document deals with the provision of appropriate pathways and spaces in vertical and horizontal MPS sites for the delivery of fibre to the premises infrastructure in new developments. This document outlines NBN Co's conduit and spatial requirements within an MPS in order for its fibre to the premises infrastructure to be deployed.
In Scope	Building design guidelines for the clearances and pathways required to survey, design and install equipment for NBN Co within a New Development MDU
Out of Scope	<ul style="list-style-type: none"> • Any building design guidelines for the clearances and pathways for Brownfield MDU sites • Any specific recommendations for acceptable vendor products in relation to cable management options

1.1 Related Documents

Documents associated with this document include:

Document	Owner/Link
[1] AS/NZS 1477:2006 PVC pipes and fittings for pressure applications	Standards Australia
[2] AS/NZS 2032:2006 Installation of PVC pipe systems	Standards Australia
[3] AS/NZS 2053:2001 Conduits and fittings for electrical installations	Standards Australia
[4] AS/NZS 3080:2003 Telecommunications installations – Generic Cabling for commercial premises	Standards Australia
[5] AS/NZS 3084:2003 Telecommunications pathways and spaces for commercial buildings	Standards Australia
[6] AS/ACIF S008:2006 Requirements for customer cabling	Australian Communications Industry Forum
[7] AS/ACIF S009:2006 Installation requirements for customer cabling	Australian Communications Industry Forum
[8] NBN-TE-CTO-194 New Developments: Deployment of the NBN Co Conduit and Pit Network – Guidelines for Developers	CTO/NAT
[9] Building Code of Australia	www.abcb.gov.au/

1.2 About This Version

Changes in this document version 4.0 dated 21st March 2013 compared to the previous 3.0 dated 14th January 2013 are summarised below:

Section	Details
4.5, 4.9, 4.9.2, 4.9.3 and Appendix B	Addition of Outdoor NTD requirements for Essential Services, and NTD Enclosure. Included ventilation requirements.

Important Note		<p>THIS DOCUMENT IS ONLY A GUIDE FOR CONTRACTORS PREPARING MULTI-PREMISES UNITS FOR INSTALLATION OF THE NATIONAL BROADBAND NETWORK.</p> <p>This document should not be relied upon by any Contractor or any other person as a substitute for knowledge, experience, care and skill or any other legal or contractual obligation.</p> <p>It is the responsibility of all Contractors to become familiar and comply with all applicable laws and contractual obligations.</p> <p>Nothing in this document will affect any rights NBN Co has (whether at law or under contract), or any obligations or warranties given by the Contractors to NBN Co.</p>
----------------	---	---

2 Introduction

The term Multi-Premises Site (MPS) refers to any development of two or more premises (also known as living units, premises or dwellings) that are joined by a common wall or property boundary and are generally managed by a Body Corporate. Examples of an MPS include apartments, town houses, retirement villages, groups of strata title units and the like. In addition to living units, an MPS can also include retail and commercial premises. An MDU (multi-dwelling unit) is a category of MPS that only contains living units (no retail/commercial premises).

2.1 Scope

This document addresses the internal space requirements and minimum clearances required to assist in the implementation of the NBN Co fibre network build where a shared common building services entry (Lead-in) is utilised to access the street fibre network.

The intended audience are any of the following:-

- Developer or Designer
- Developer's Consultant
- Developer's Building Contractor
- NBN Co Designer or Planner

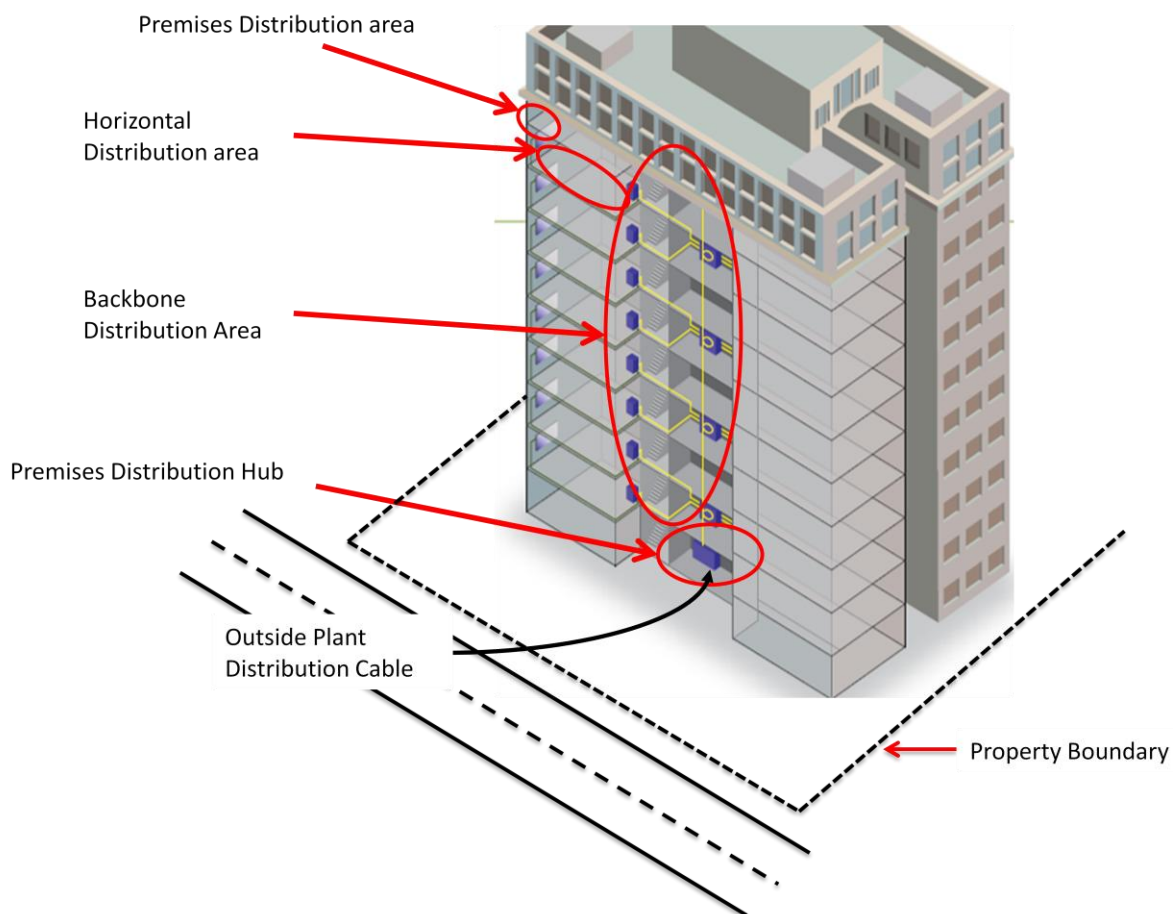

Figure 1: Basic network elements in relation to a typical MPS

2.2 General Requirements

2.2.1 New Development MPS / MDU

The Developer, Developer's consultant or contractor are responsible for the following:-

- Provision of a suitable lead-in from the property boundary to the building entrance facility through to any area designated for Telecommunications services. Where diversity or other special needs exist, an alternative entry location may also be required.
- Provision of suitable space and access for the installation, maintenance and repair of all NBN Co. network elements up to and including the Network Termination Device (NTD) and Power Supply Unit (BBPSU).
- Provision of a minimum of P23mm nominal inside diameter, white, rigid communications conduit with draw string, from either the telecommunications room or riser/closet location to each NTD location.

NBN Co is responsible for:

- The cabling, installation and maintenance of all network elements up to and including the NTD and BBPSU, with the exception of the BBPSU batteries originally supplied at the time of installation.
- Compliance to the Building Code of Australia for all cabling and with reasonable directions provided by authorised developers, builders, owners, managers and customers in respect to building and fire authority requirements. In the cases where requests are received which are regarded as unreasonable, advice may be sought.

2.3 ACMA Wiring Rules

The ACMA wiring rules do not apply to cabling up to and including the network boundary point. Any cabling work performed on the customer side of the network boundary point is subject to ACMA requirements. Cabling work includes the connection, installation or maintenance (repair) of customer cabling.

2.4 Network Boundary Point

The Network boundary point will be at the service output ports on the NBN Co. NTD, i.e. the data (UNI-D) and phone (UNI-V) service sockets on the rear of the NBN Co. NTD. (As per AS/ACIF S009 – 2006) the NTD is labelled as a Network Termination Device (NTD).

2.5 Essential Services

When servicing an essential service, such as a lift phone, managed alarm system or fire panel the Outdoor NTD device must be used. The Outdoor NTD unlike the Indoor NTD has specific earthing requirements as described below. Refer to Section 2.5.1 Mounting Surface Template for Outdoor NTD spatial requirements.

Note: The CET earth must be provided by a licensed electrician engaged by the developer or construction crew.

The Outdoor NTD specific earthing requirements:

- Earthing conductor for the NBN Outdoor NTD must be earthed for safety reasons and for remote testing purposes.

- Where the electrical earth electrode is near the NBN Outdoor NTD and is accessible, a 6 mm² green/yellow equipotential bonding conductor may be run between the Outdoor NTD and the electrode and must be connected to the electrode by a separate earthing clip. The connection must be labelled “Telecommunications Bonding Conductor” or “NBNC_o” in accordance with the requirements of AS/NZS 3000.
- Provide a 6 mm² green/yellow equipotential bonding conductor between the earthing bar in the electrical switchboard and a Communications Earth Terminal (CET) in the communications compartment of the combined enclosure or, where a combined enclosure has not been provided, located near — but not in — the switchboard (in accordance with Clause 5.6.2.7 of AS/NZS 3000:2007); and
- Where a combined enclosure is not used, run a 2.5 mm², 4 mm² or 6 mm² green/yellow earthing conductor from the CET to the NTD location.

This arrangement is shown below:

- The length of the equipotential bonding and earthing conductors is unimportant for the purpose of earthing the Outdoor NTD, as this earth is provided for electrical safety reasons, not for lightning surge protection purposes.
- The earthing conductor need not be installed in conduit within the wall cavity.
- The earthing conductor must be tied or taped to either the lead-in conduit or the customer cabling conduit (the earthing conductor may enter either the left hand or the right hand cable entry port, whichever is more convenient).

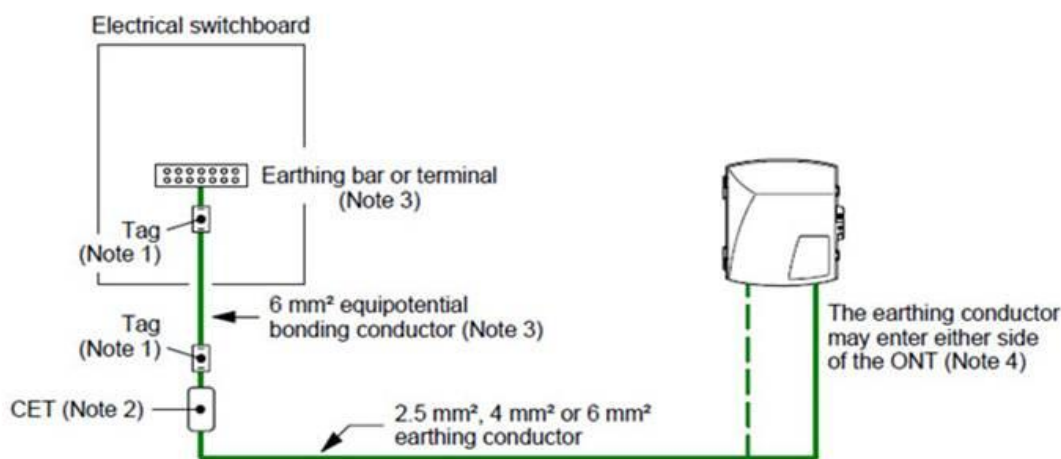
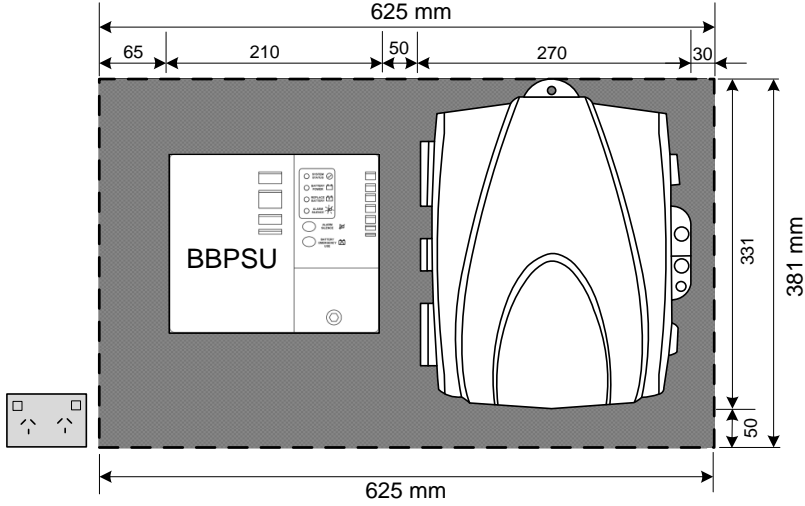

Figure 2 - Earthing Requirements

NOTES:

1. The bonding conductor must be labelled “Telecommunications Bonding Conductor” at the switchboard end and also at the Communications Earth Terminal (CET) end if the CET is not within sight of the switchboard.
2. The CET must be located within 1m of the essential services outdoor NTD.
3. A licensed electrician must make the bonding conductor connection inside the electrical switchboard.
4. The earthing conductor will be connected to the Outdoor NTD by the NBNC_o installer. MPS / MDU Specifics

2.5.1 Mounting Template

Parameter	Mounting Surface Template for Outdoor NTD
A landscape layout ¹ of the Outdoor NTD	 <p style="text-align: center;">Figure 3 – Outdoor NTD Composite Layout (Landscape)</p> <p>Note: A GPO must be provided by the end user outside the area assigned for the installation of NBN Co's equipment².</p>

¹ Additional area must be provided if the Open Enclosure / Home Distributor is designed for non-NBN Co cable patching, devices or equipment.

² The position of the GPO in these diagrams are for illustrative purposes only. The GPO may be positioned anywhere adjacent to the perimeter of the Mounting Surface Template and as close as practical to it, in accordance with wiring standards. The electrician should avoid mixing power cabling with data, telephone, RF and fibre in the same vertical corridor.

Parameter	Mounting Surface Template for Outdoor NTD
A portrait layout of the Outdoor NTD	<p>Figure 4 – Outdoor NTD Composite Layout (Portrait)</p> <p>Note: A GPO must be provided by the end user outside the area assigned for the installation of NBN Co's equipment³.</p>

Table 1 - Outdoor NTD Mounting Template

³ The position of the GPO in these diagrams is for illustrative purposes only. The GPO may be positioned anywhere adjacent to the perimeter of the Mounting Surface Template and as close as practical to it, in accordance with wiring standards. The electrician should avoid mixing power cabling with data, telephone, RF and fibre in the same vertical corridor.

2.6 NBN Co's MPS Categories

An MPS is classified by NBN Co. according to the types of buildings on a building site or development. Each MPS within a development can be categorised by one of the following definitions:

MDU Category	Characterisation
Horizontal	Close resemblance to single dwelling units in a street. Buildings maybe clustered into semidetached or terrace arrangements, but the entry facility is common for at least two living units. Pathways between living units resemble those detailed in document NBN-TE-CTO-194.
Vertical	Multiple floors, multiple living units per floor, likely to have several vertical spaces for services. Includes one or more telecommunications rooms/spaces as per AS/NZS 3084:2003.
Hybrid	Multiple buildings on a site. Apartments in horizontal and vertical configurations that may have common access pathways between structures. Multiple access spaces are generally required.

Table 2 – MPS Categories

2.7 General Requirements

This section specifies the minimum requirements for the various MDU/MPS types, however, these are standard guidelines only. Please refer any concerns to NBN Co for non-standard installations or specific recommendations.

2.7.1 Basic Principles

The following installation principles apply:

- Space requirements must be applied in accordance with AS/NZS 3084:2003, unless otherwise specified in this document.
- The NTD and BBPSU must be located in an area that is controlled by the end user at all times.

2.7.2 Lead-in to the Building Entry

- **1 – 60 premises**

NBN Co requires 1 x white 63mm (nominal internal diameter) PVC conduit with a minimum wall thickness of 3.45mm.

- **Greater than 61 premises**

NBN Co requires a minimum of 1 x P100 telecommunications conduit.

2.8 Space Requirements for MDU/MPS Products

2.8.1 Basement or Telecommunications Room

The size of an MPS and the solution required will determine the amount of space required. A dedicated telecom room is desired but not required. For example, if a Premises Distribution Hub (PDH) is required to service the building, an adequate space to mount and work on and around the cabinet is required – whether or not it is in a dedicated telecom room.

The specific area and clearance requirements will depend upon the number of premises being supported since that will determine the number and type of hardware products to be installed. Refer to Figure 5 for the generic clearance/space requirements for an MPS that requires a PDH cabinet with dimensions of 800 x 600x 400 (mm). Access clearances are defined in AS/ACIF S009:2006, figures D.2 and D3 [7] and must be referred to for complete guidance. This configuration may be replicated multiple times for very large developments, however it is recommended to refer the layout/design to NBN Co for each large installation to confirm compliance. The PDH is required when there are 60+ residential premises. Otherwise a CTL is used.

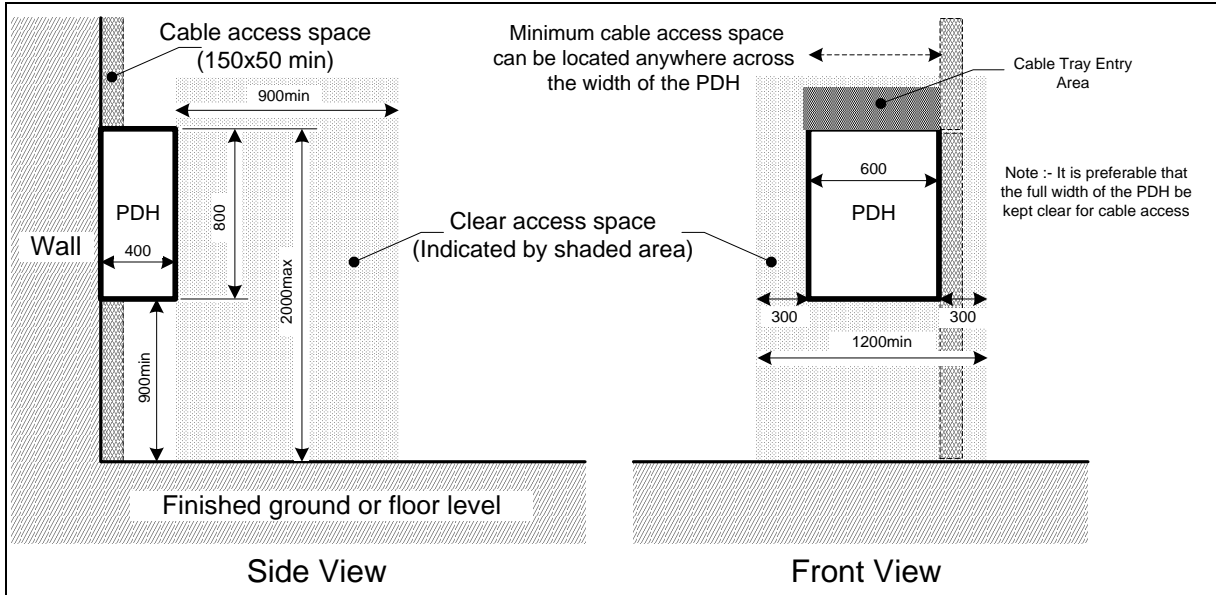

Figure 5: Example Fibre / Premises Distribution Hub/Internal Locations Clearance Requirements

2.8.2 Cable Transition Location (CTL) Enclosure

A CTL may be mounted outside on the side of the MPS or inside. The clearance requirements are shown below.

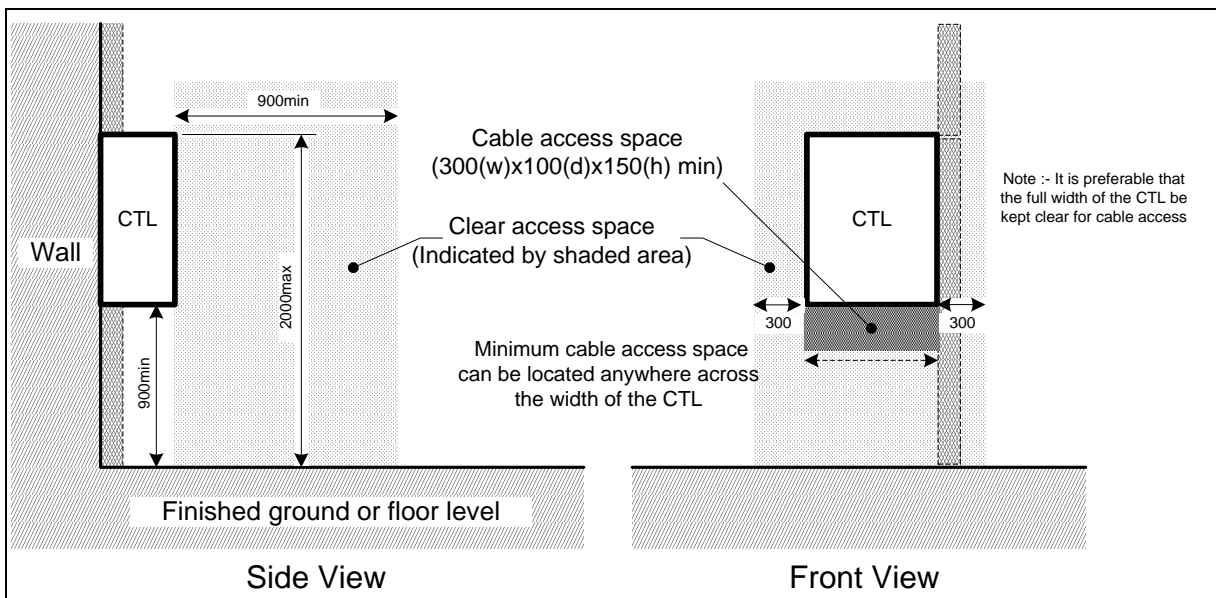

Figure 6 - Example CTL Clearance Requirements

2.8.3 Telecommunications Riser/Closet

There are two main products that will be mounted in a telecommunications riser/closet: The Fibre Collector Distributor (FCD) and the Fibre Distribution Terminal (FDT).

There are three types of dimensions referenced below:

1. The minimum space required to physically mount an FCD or FDT to a wall.
2. The minimum clearance required around a FCD/FDT or grouping of products (the working height and space)

2.8.4 Working Height and Space

Telecommunication products need to be mounted at a comfortable working height and need to have sufficient access space around the product(s) for initial installation, ongoing maintenance, configuration modifications, and troubleshooting.

An FCD and FDT have the following minimum requirements see below:

- Mounted no closer to the floor than 450mm from the bottom of the FCD/FDT, and no higher than 1800mm to the top of the FCD/FDT.
- Minimum of 900mm clear space in front of the FCD/FDT.
- Minimum of 300mm on each side of the FCD/FDT (or on each side of a grouping of FCD/FDTs).

The telecommunications closet/riser is also required to have a minimum 50x50 mm floor slot or 1 x white telecommunications conduit cut nominally 25mm above or below the floor slab, as appropriate (see Figure 8). If there are living units above and below the floor slab, bi-directional access is required.

Note: The diagrams in this section do not include the conduit or other pathway to units.

Any fire stopping requirements for penetrations of the walls, floors or ceilings must be installed in accordance with the Building Code of Australia (BCA)

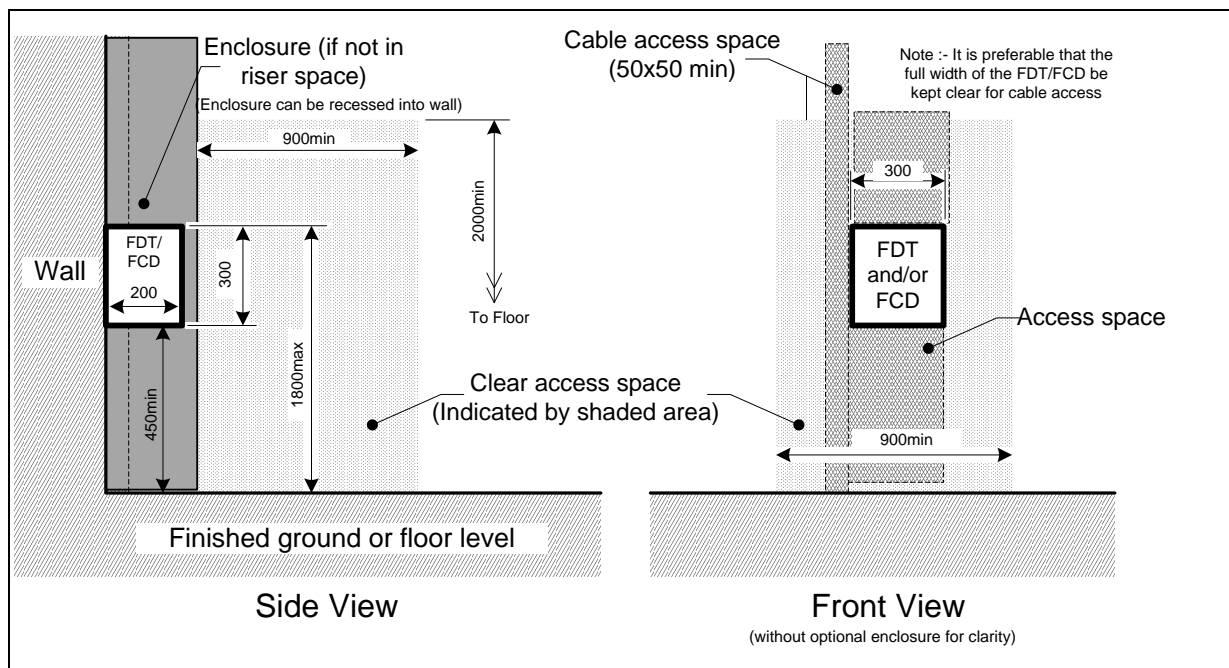

Figure 7 - Example of access clearances for a single FDT or FCD (all dimensions in mm)

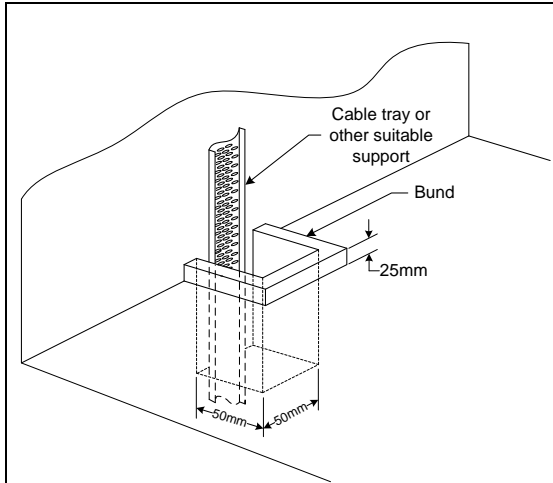

Figure 8 - Slot Example Telecommunications Riser/Closet Floor or Ceiling Entry

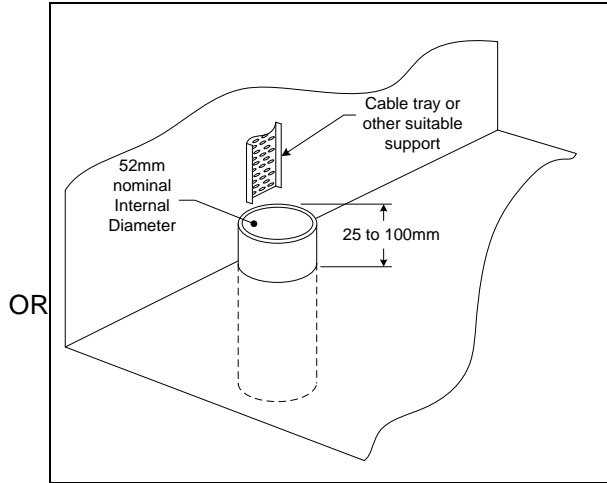

Figure 9 - Sleeve Example Telecommunications Riser/Closet Floor or Ceiling Entry

Note: For vertical pathways between floors, as a minimum the ability to anchor cables every 800mm is required.

2.9 Pathways

2.9.1 Property boundary to Telecommunications room:

Communication pathways may be provided using the option below

Note: Conduits require draw string

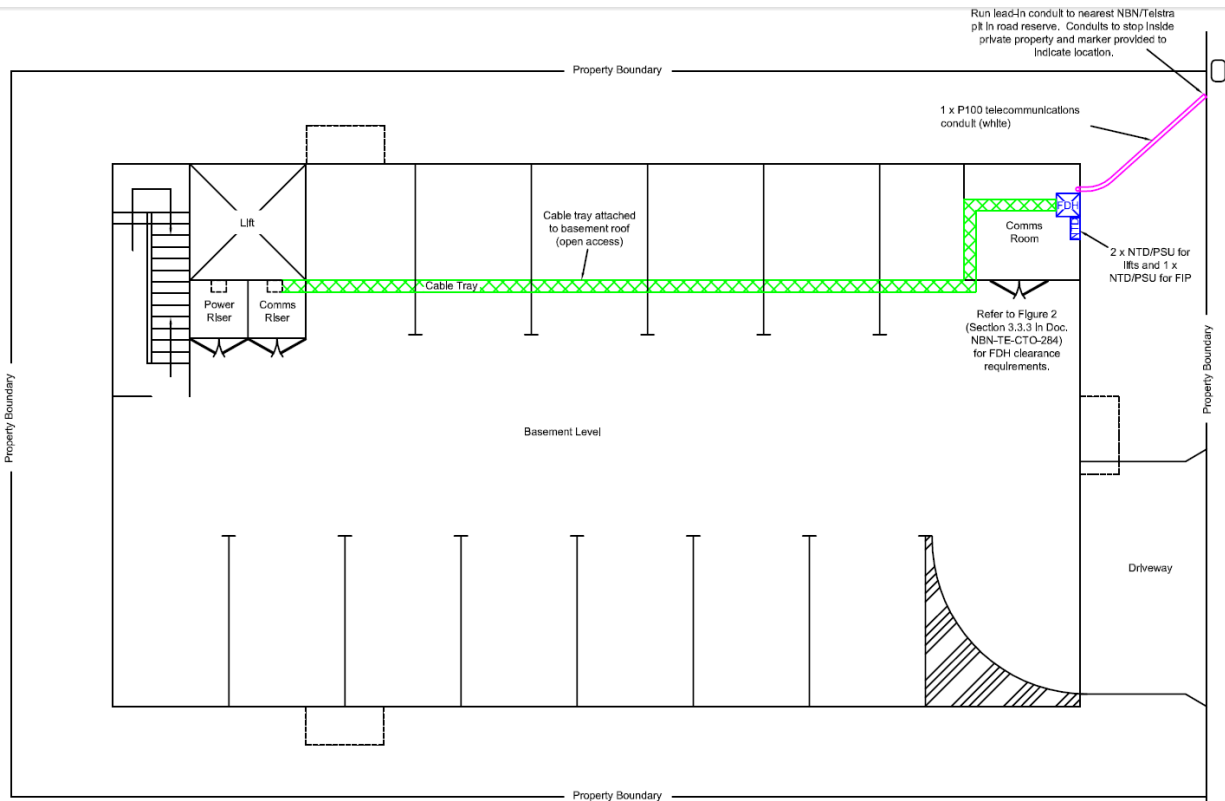

Figure 10 - NBN Co Concept Pathway from Property Boundary to Communications Room

2.9.2 Telecommunications Riser/Closet to Living Unit

Communications pathways may be provided using the options below. Options 1 & 2 will be used in new development MPS.

Option 1: Dedicated Conduit

Cabling from the Living Unit to the Telecommunications Riser/Closet requires a minimum of a P23mm inside diameter rigid white communication conduit with a draw string from the Telecommunications Riser or Closet location to each NTD location within a premise. No section of conduit shall be longer than 50 metres between pull/draw points and contain the equivalent of no more than three 90° 300mm radius bends. Conduits can be surface mounted in common areas or cast 'in slab'

Notes: All conduits must contain a labelled draw string referencing Apartment/Unit number.

A single 100mm radius bend maybe used to replace a 300mm radius bend as the final transition from horizontal to vertical with agreement of the relevant NBN Co representative

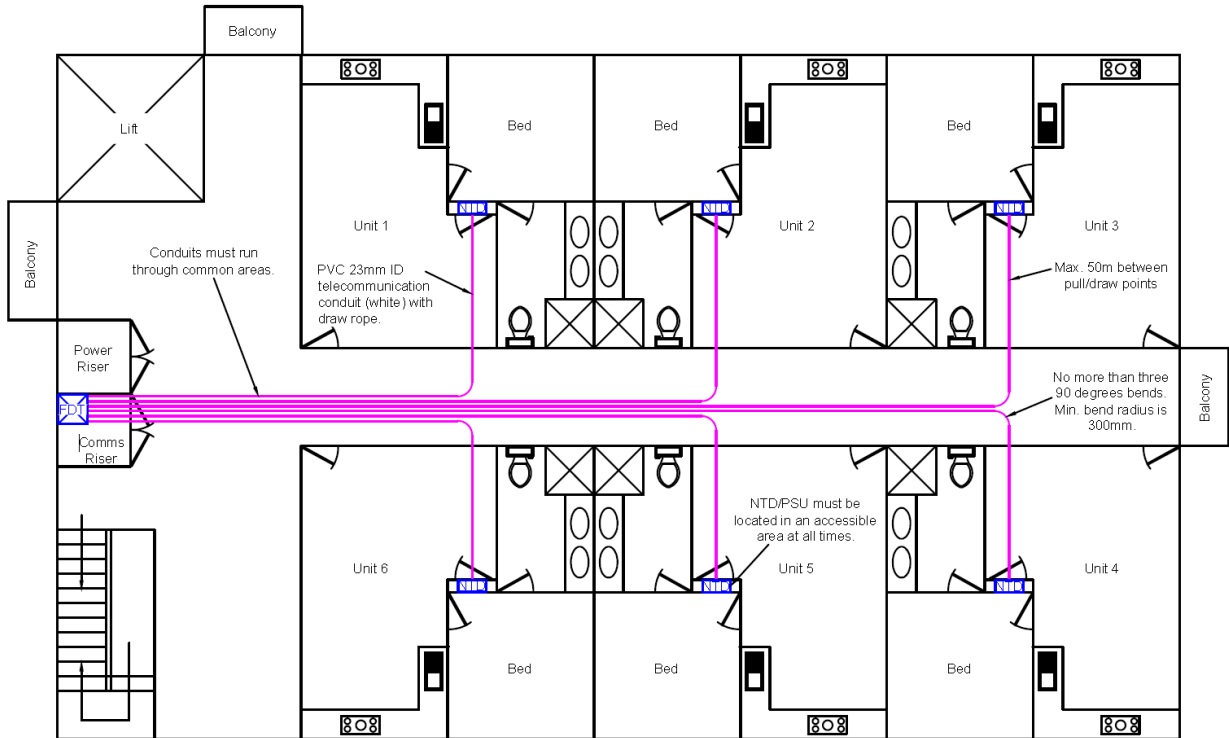

Figure 11 - NBN Co Pathway using all P23 ID conduit to feed typical Apartment floor Example layout 1

Option 2: Cable Tray and Conduit

Where a combination of cable tray and conduit is utilised for cabling from the Telecommunications Riser/Closet to the living unit, access panels must be provided at any change of direction of cable tray, cable tray/conduit transition or no more than 15m apart.

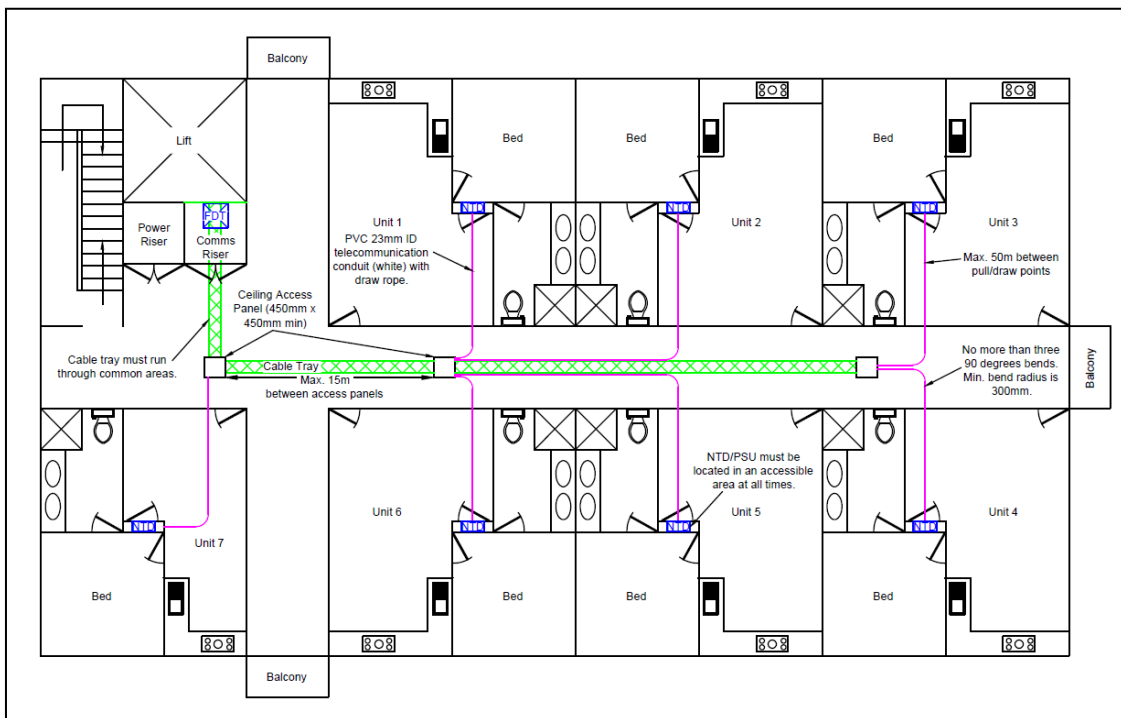

Figure 12 - NBN Co Pathway using combination Cable Tray and P23 ID conduit to feed typical Apartment floor Example layout 2

The allowable pathway solutions in order of preference by NBN Co are as follows:

1. P23mm nominal internal diameter rigid communications conduit
2. P63mm ID Rigid Communications Trunk Conduit
3. Cable tray

2.9.3 Living Unit

The Mounting Surface Template must meet or exceed the dimensions below.

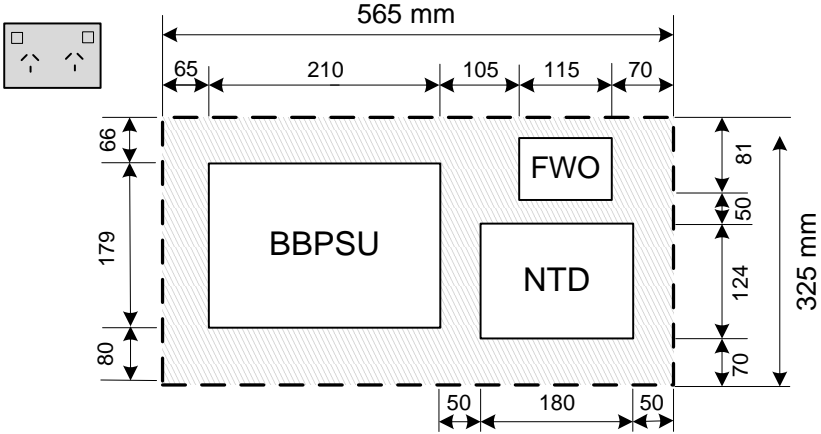
Parameter	Mounting Surface Template for Indoor NTD (I-240G-R)
Mounting Surface Template for a landscape orientation	 <p style="text-align: center;">Figure 13 – Indoor NTD Landscape Orientation</p> <p>Note: A GPO must be provided by the end user outside the area assigned for the installation of NBN Co's equipment.⁴</p>

⁴ The position of the GPO in these diagrams are for illustrative purposes only. The GPO may be positioned anywhere adjacent to the perimeter of the Mounting Surface Template and as close as practical to it, in accordance with wiring standards. The electrician should avoid mixing power cabling with data, telephone, RF and fibre in the same vertical corridor.

Parameter	Mounting Surface Template for Indoor NTD (I-240G-R)
Mounting Surface Template for a portrait orientation	<p style="text-align: center;">Figure 14 - Mounting Template Indoor NTD Portrait</p> <p>Note: A GPO must be provided by the end user outside the area assigned for the installation of NBN Co's equipment⁵.</p>

Table 3 - Indoor NTD Mounting Template

⁵ The position of the GPO in these diagrams is for illustrative purposes only. The GPO may be positioned anywhere adjacent to the perimeter of the Mounting Surface Template and as close as practical to it, in accordance with wiring standards. The electrician should avoid mixing power cabling with data, telephone, RF and fibre in the same vertical corridor.

The minimum space required for the installation of NBN Co's NTD, PSU and FWO is set out below.

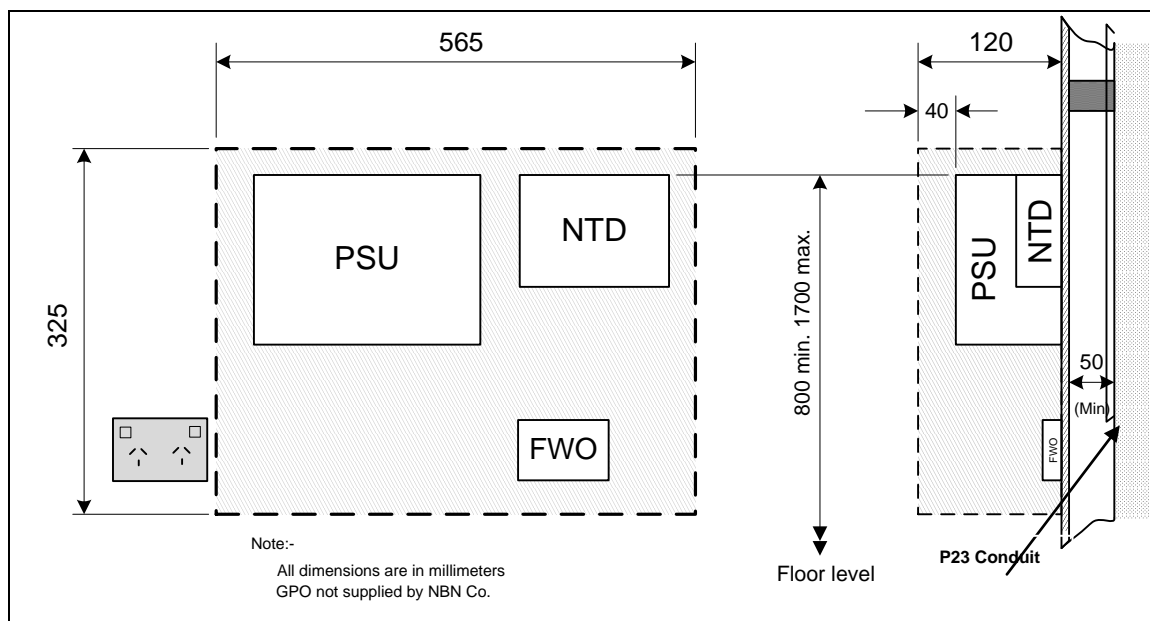

Figure 15 - NBN Co NTD and PSU Dimensions and Clearance Requirements

2.9.3.1 Minimum Home Distributor dimensions

NBN Co equipment may be installed into a Home Distributor that meets or exceeds the following size requirements.

Parameter	Home Distributor Dimensions
Minimum mounting surface area required for an Indoor NTD composite layout	2,000 square centimetres, measured within the Home Distributor. ⁶
Minimum mounting surface area required for an Indoor PSU composite layout	2,000 square centimetres, measured within the Home Distributor. ⁶
Minimum internal clearance between NBN Co equipment and Home Distributor door / cover	2 centimetres
Minimum inside volume required for a Home Distributor	20 litres. ⁶

Table 4 - Home Distributor Dimensions

⁶ This volume is sufficient to accommodate the I-240G-R Indoor NTD, the Battery Backup BBPSU, a FWO and GPO. Additional volume must be provided to accommodate patch panels or other end user equipment.

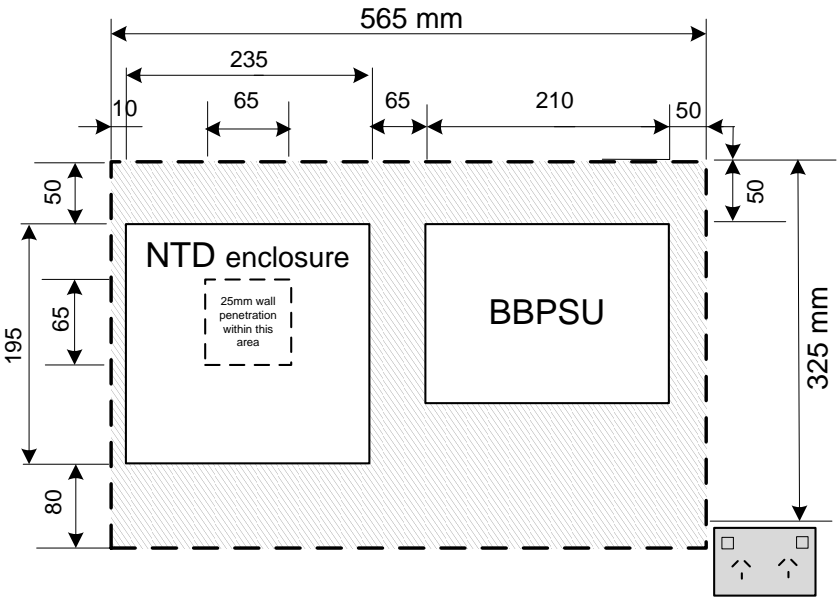
Parameter	Mounting Surface Template for NTD Enclosure
Mounting Surface Template for a landscape orientation	 <p data-bbox="655 875 1198 904">Figure 16 – NTD Enclosure Landscape Orientation</p> <p data-bbox="451 916 1394 981">Note: A GPO must be provided by the end user outside the area assigned for the installation of NBN Co's equipment⁷.</p>

⁷ The position of the GPO in these diagrams are for illustrative purposes only. The GPO may be positioned anywhere adjacent to the perimeter of the Mounting Surface Template and as close as practical to it, in accordance with wiring standards. The electrician should avoid mixing power cabling with data, telephone, RF and fibre in the same vertical corridor.

Parameter	Mounting Surface Template for Indoor NTD (I-240G-R)
Mounting Surface Template for a portrait orientation	<p style="text-align: center;">Figure 17 – NTD Enclosure Portrait Orientation</p> <p>Note: A GPO must be provided by the end user outside the area assigned for the installation of NBN Co's equipment⁸.</p>

Table 5 - NTD Enclosure Mounting Template

2.9.4 Installation Specifications and Rules for NTDs and BBPSUs

Note: The Indoor NTD and its BBPSU are suitable for installation in Standard Circumstances

All of the following checks must be true for an installation to be categorised as 'Standard Circumstances':

1. The NTD and BBPSU are installed in a building where people normally live, work or meet⁹, but not in a place that is open to public access.
2. The NTD and BBPSU
 - a. **are** installed inside the same building as each other
 - b. **are not** installed on the external surface of an external wall¹⁰, and

⁸ The position of the GPO in these diagrams is for illustrative purposes only. The GPO may be positioned anywhere adjacent to the perimeter of the Mounting Surface Template and as close as practical to it, in accordance with wiring standards. The electrician should avoid mixing power cabling with data, telephone, RF and fibre in the same vertical corridor.

⁹ This means that the Indoor NTD and BBPSU should not be installed in a building or structure separate from where the services will be reticulated, or in a hut or street cabinet or another kind of enclosure such as a telephone booth where the environmental conditions may extend outside the specifications permitted for the NTD, BBPSU or battery.

- c. **are not** installed in an enclosure situated on or embedded into the external surface of an external wall¹⁰ of the building;
3. The end user cabling¹¹ remains wholly within the same building containing the NTD and BBPSU¹².
4. If a Battery Backup BBPSU is deployed, it is mounted and semi-permanently secured to a wall or permanent fixed enclosure.
5. Neither the NTD nor BBPSU are installed in a situation where they might be reasonably expected to experience damp, moist or excessively humid conditions.
6. Neither the NTD nor the BBPSU are installed within a roof cavity.
7. Neither the NTD nor the BBPSU are installed below a floor outside the normal living, working or occupancy areas of the building¹³.

¹⁰ The 'external surface of an external wall' refers to the outside of a building, and would include, as an example, an undercover area within an enclosed patio, plus similar circumstances. The installation of an NTD and BBPSU on the 'internal surface of an external wall' refers to the inside of a building and this situation is not meant to be precluded by these points, however may fall under other circumstances outlined later in this list.

¹¹ End user cabling includes any cables that contain electrical conductors or conductive components, for the purpose of reticulating any UNI-V or UNI-D service, or reticulating BBPSU power. This term is intended to mean the same as the term 'customer cabling' in AS/CA S009.

¹² This means that there must not be any electrically conductive telephone or data or BBPSU power cables between the main building and a separate freestanding building.

¹³ This means that neither the NTD nor the BBPSU may be installed under a home between the floor and bare earth, or in a location that cannot be locked up.

8. Neither the NTD nor the BBPSU are installed in a cupboard / Enclosure / Home Distributor or in a confined space where
 - a. it might reasonably be expected that linen, clothing or towels might be stored in direct contact with the NTD or BBPSU, or
 - b. it might be reasonably presumed that items could be stored that restrict free airflow around the NTD or BBPSU, or
 - c. gases may be trapped due to limited or no ventilation¹⁴, or because the design or situation of the Enclosure / Home Distributor is such that there is a potential for ventilation to be inhibited.
9. Neither the NTD nor the BBPSU are installed
 - a. in a location where the ambient temperature in the immediate vicinity of the NTD or BBPSU might routinely exceed +40C¹⁵ or fall below 0C or
 - b. on a surface where the surface temperature might routinely exceed +40C¹⁵ or fall below 0C.
10. Neither the NTD nor the BBPSU are installed in a location where the power or end user cabling¹¹ might
 - a. be a tripping or strangulation hazard¹⁶, or
 - b. be accidentally wrenched or damaged by tripping, passing by, or another inadvertent disturbance.
11. Neither the NTD nor the BBPSU are installed
 - a. onto an accessible conductive / metallic surface or
 - b. into a conductive / metallic enclosure with accessible metallic parts;
 - c. encompassing a General Purpose Outlet (powerpoint) unless all accessible conductive surfaces and parts have been protectively earthed in accordance with AS3000 and AS/CA S009¹⁷.
12. The BBPSU AC power cord is not routed through an opening in a metallic surface unless the metallic edges of that opening are appropriately protected by a grommet or similar device.
13. Neither the NTD nor the BBPSU are at risk of being damaged.

¹⁴ VRLA batteries, of the kind used in the Battery Backup Power Supply Unit, may emit hydrogen and oxygen gas under some circumstances, such as battery overcharging. VRLA batteries may be installed into office or end user enclosures providing the enclosure provides for exchange of air with the ambient atmosphere, as described in section 2.4 of AS/NZS 4029.2. While not strictly applicable to NBN Co's application, sections 2.6 and 2.7 of AS 4086.2 provide cogent recommendations.

¹⁵ This means that neither the NTD nor the BBPSU may be installed directly onto a northern or western facing masonry wall where (a) the wall is likely to be subjected to heating through solar loading and the heat may be transferred to the surface on which the NTD or BBPSU is mounted, or (b) near a space or water heater or a heater vent. Note that Indoor NTDs and BBPSUs may be installed on northern or western facing masonry cavity walls if the cavity is fitted with R1.5 or higher rated batts.

Also note that if a wall would be subjected to solar loading but for a tree that is currently providing shade, the installer should assess future circumstances assuming the tree has been removed.

¹⁶ Cables and equipment must be installed in accordance with local OH&S regulations and requirements. It is beyond the scope of this document to specify values.

¹⁷ This addresses potential breaches of primary insulation, inadvertent detachment of live conductors coming into contact with exposed metallic parts, and other potential risks in situations where conductors carrying mains potential are routed into conductive / metallic enclosures. Refer to 2.7 of AS/CA S009.

2.9.5 Ventilation requirements

Open Enclosure Areas and Home Distributors used for NBN equipment must meet all of the following ventilation requirements.

If there is no possibility that the opening to an Open Enclosure might be obstructed in a way that impairs the ventilation of the equipment it contains, the Open Enclosure can be deemed to meet the requirements of this section.

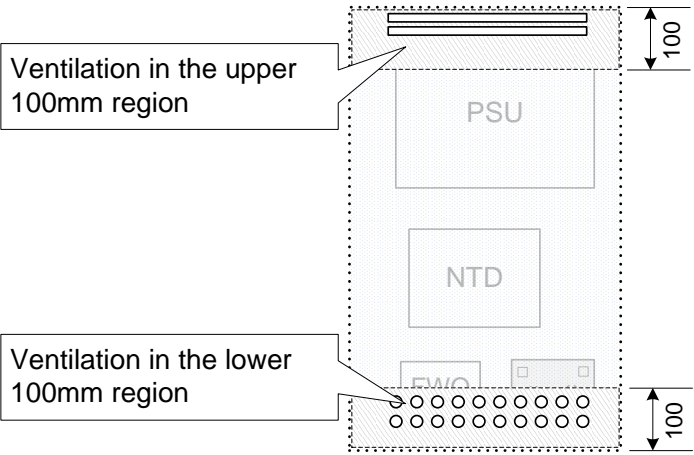

Parameter	Ventilation Requirement
 Maximum Ingress Protection (IEC 60529) rating	IP2x ¹⁸ (Individual ventilation openings must exceed 2.5mm in diameter or in their short dimension)

¹⁸ This means that the IP rating of the Home Distributor must fall into any of the categories IP0x, IP1x or IP2x, but **must not fall into categories IP3x, IP4x, IP5x or IP6x.**

Parameter	Ventilation Requirement
 <p>Ventilation to dissipate gases released during battery charging</p>	<p>a. Ventilation must be provided in an ‘Upper Ventilation Region’ no further than 100mm from the top surface of the Open Enclosure Area or Home Distributor</p> <p>b. Ventilation must be provided in a ‘Lower Ventilation Region’ no further than 100mm from the bottom surface of the Open Enclosure Area or Home Distributor</p> <p>c. The combined cross sectional ventilation area in the Upper Ventilation Region must be at least 5 square centimetres unimpeded¹⁹</p> <p>d. The combined cross sectional ventilation area in the Lower Ventilation Region must be at least 5 square centimetres unimpeded.</p> <div data-bbox="571 667 1268 1120" style="text-align: center;">  </div> <p style="text-align: center;">Figure 18 – Ventilation Upper/Lower</p> <p>This ventilation must exit towards the top/bottom, sides or front of the Open Enclosure Area or Home Distributor and must not exit into a wall cavity.²⁰</p> <p>Ventilation that may be obstructed when an Open Enclosure Area or Home Distributor is embedded into a wall cavity or surrounded by a purpose designed architrave is to be disregarded when the adequacy of ventilation is assessed.</p>

¹⁹ ‘Unimpeded’ is also intended to mean ‘unobstructed’, and refers to the minimum effective cross-sectional area of airways intended for ventilation.

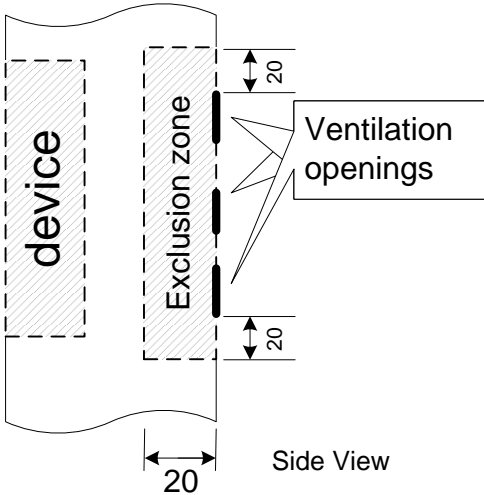
²⁰ The requirements for separate upper and lower ventilation areas may be met with (a) upper and lower circular holes each of at least 25mm diameter, (b) multiple circular holes with areas that sum to at least 5 square centimetres in each of the upper and lower enclosure spaces, (c) one or more ventilation slots in each of the upper and lower enclosure spaces with cross-sectional areas that sum to at least 5 square centimetres each.

Parameter	Ventilation Requirement
Arrangement of Enclosure / Home Distributor ventilation openings	<p>Where feasible, ventilation openings should be arranged in accordance with the recommendations of AS 4086.2²¹, and in particular:</p> <p>ventilation openings should be distributed across the breadth of the upper and lower ventilation regions of the Enclosure / Home Distributor, as close to the top and as close to the bottom of the enclosure as practical</p> <p>ventilation openings should be positioned to ensure airflow across both the NTD and the Battery Backup BBPSU</p>
 <p>Proximity of a ventilation opening to the face of a device</p>	<p>The area delimited by the perimeter of the inner opening of a ventilation opening must be at least 20mm from any of the six faces of an active or passive device²²</p>  <p style="text-align: center;">Figure 19 – Ventilation Openings</p>
 <p>Cable ingress / egress and ventilation</p>	<p>Ventilation openings must not be used or intended to be used for cable ingress / egress²³.</p>
 <p>Doors or covers may not obstruct ventilation</p>	<p>An Open Enclosure or Home Distributor design must not rely on a cover or doors being opened to meet any of the ventilation requirements.</p>

²¹ AS 4086.2 covers ‘secondary batteries for use with stand alone power systems’, and so is not strictly applicable to NBN Co’s application which draws power from the consumer AC mains. In the absence of a relevant standard covering the battery capacity deployed in NBN Co’s Battery Backup BBPSU, we have referenced sections of AS 4086.2, which are arguably agnostic to the source of power, and provide relevant guidance regarding ventilation.

²² This is equivalent to saying that a device may not be mounted within 20mm of a ventilation hole, either in the two dimensions of the mounting surface, or in the third dimension above the mounting surface.

²³ This requirement is to ensure that cables cannot obstruct and reduce the free flow of air into and out of the Open Enclosure or Home Distributor, thereby compromising the ventilation.

Parameter	Ventilation Requirement
 Compliance with standards governing safe location of VRLA Batteries and Battery Backup BBPSUs	Battery Backup BBPSUs must not be installed onto a wall area, or into an Open Enclosure or Home Distributor if an unenclosed Battery Backup BBPSU would be contrary to local standards or regulation at that location²⁴

Table 6 – Ventilation Requirements

²⁴ Batteries should not be situated in areas where gas emission, however minor, could give rise to safety risk. Installing the Battery Backup BBPSU into an Open Enclosure or Home Distributor that is itself in such an area will not mitigate a latent safety risk so the BB BBPSU should not be installed in such locations

Appendix A – Key Terms

Term	Description
ACMA	Australian Communications and Media Authority. It is the Federal Government body that licenses Australia's telecommunications carriers and regulates fixed line and mobile telecommunications.
BCA	Building Code of Australia
CPE	Customer Premises Equipment
CTL	Cable Transition Location
FCD	Fibre Collector Distributor
FDA	Fibre Distribution Area. The area served via a single Fibre Distribution Hub (FDH)
FDH	Fibre Distribution Hub
FDT	Fibre Distribution Terminal
FWO	Fibre Wall Outlet
FSA	Fibre Serving Area
FSAM	Fibre Serving Area Module
GPO	General Purpose Power Outlet
IMC	Internal Multi-fibre Cable
ISDC	Internal Service Drop Cable
LFN	Local Fibre Network
Living Unit	A valid physical address in the Geocoded National Address File (GNAF) provided by PSMA Australia Limited.
MDU	Multi-Dwelling Unit: Refers to blocks of flats, apartments etc. that is made up entirely of residential premises. MDU is a type of MPS.
MPS	Multi-Premises Site: Refers to blocks of flats, apartments etc. that includes both residential premises <u>and</u> retail/commercial premises.
NTD	Network Termination Device. The NTD is an active device that terminates the optical signal from the NBN and then provides one or more Service Delivery Points (SDPs) as physical electrical interfaces.
ODF	Optical Distribution Frame. A passive device which terminates cables, allowing arbitrary interconnections to be made.

PUBLIC

Term	Description
ONT	Optical Network Terminal. Generic term for the device at the user / customer end of an optical communication network – referred in NBN documentation as an NTD.
OSP	Outside Plant
Patch cord	A cable with connector(s) on both ends.
PCD	Premises Connection Device. A connection-point; box, or connector where drop fibre cable finishes and Premises fibre cable commences. May incorporate ‘slack’ cable storage. A convenient place to cease build drop activity and commence customer connection activity.
Pigtail	A cable with connector(s) only on one end.
PDH	Premises Distribution Hub. Similar to a Fibre Distribution Hub however located within a premises
Premises	A Residence, Unit, House, Occupancy, Tenancy, Retail, Shop Front, Hotel, Hostel, Doctor, Medical, Clinic, Medical Imaging Centre, Laboratory, Living Unit etc. Also, a valid physical address in the Geocoded National Address File (GNAF) provided by PSMA Australia Limited.
POI	Point of Interconnect
BBPSU	Power Supply Unit

Table 7 - Acronym Definitions

Appendix B – MPS/MDU Pathway Design Checklist

Greenfield MPS/MDU Pathway Design Checklist

Check the following detail:

<input type="checkbox"/>	1. Ensure a floor plan for each different floor layout is supplied depicting the communication pathway from Riser Cupboard to Apartment (like floors can be shown on one floor plan).
<input type="checkbox"/>	2. Ensure the lead-in pathway is shown going from the Property Boundary to the Communications Room (conduit, cable tray or combination of both).
<input type="checkbox"/>	3. Provide a front elevation of riser cupboard layout with space reserved for NBN Co equipment is provided (FCD/FDT).
<input type="checkbox"/>	4. Ensure Communications Room has the spatial requirements for NTD/BBPSUs to service lifts and FIP. Note: 1 x NTD/BBPSU combination per lift and 1 x NTD/BBPSU per FIP. Provide a front elevation of communications room and/or cupboard layout with space reserved for NBN Co equipment is provided (PDH and essential services CPE). Note: NTD/BBPSU combinations for essential services can be located in alternate locations upon consultation and agreement with your NBN Co Account Manager.
<input type="checkbox"/>	5. Ensure pathways from the communications room to each riser are shown (conduit, cable tray or combination of both).
<input type="checkbox"/>	6. Ensure the riser cupboard shows an FDT on each floor and the spatial dimensions of the riser cupboards are in accordance with NBN Co guidelines.
<input type="checkbox"/>	7. Provide a schematic of the riser shaft depicting the distance between floors.
<input type="checkbox"/>	8. If the pathways from the riser cupboard to the apartment are a full conduit solution, then depict each individual pathway in no more than three bends.
<input type="checkbox"/>	9. If the pathway from the riser cupboard to the apartment is a combination conduit/cable tray then Access Panels must be depicted in the designs at every “cable tray” change in direction as well as any point where the individual P23 ID lead-ins meet the cable tray. Access Panels will be no longer than 15m apart.
<input type="checkbox"/>	10. The location and spatial separations for the NBN Co CPE (NTD/BBPSU/FWO) must be in accordance with NBN Co Guidelines.
<input type="checkbox"/>	11. All Design Drawings must be submitted in .dwg format to scale utilising NBN Co Cad Package.

PUBLIC

	<p>Note: All .dwg format pathway design drawings must be a single DWG/CAD with all information built in the file. No attachment/ binding OR X-Ref.</p> <p>All Technical Guidelines can be found at the NBN Co Website http://www.nbnco.com.au/getting-connected/new-developments/new-developments-technical-guidelines.html</p>
<input type="checkbox"/>	12. Floor plans denote Apartment/ Unit numbers.
<input type="checkbox"/>	13. For Horizontal or Hybrid MDUs the Developer must submit Pit and Pipe Asbuilts that adhere to the NBN Co technical guidelines before CRM status can be "Design Accepted" (for Hybrid MDUs checkpoints 1-11 must be checked as well)

For any clarification on the Communications Pathway designs please refer to your NBN Co Account Manager.